

Up to PL e of EN ISO 13849-1 PNOZ 8

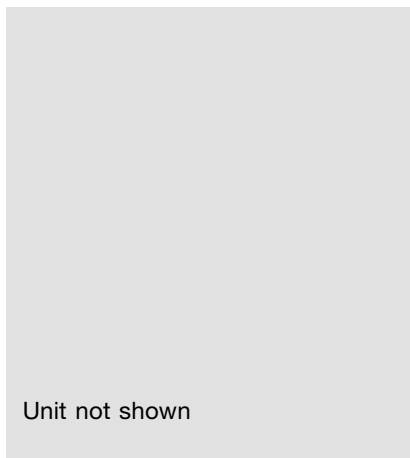



Safety relay and safety gate monitor in accordance with EN 60947-5-1, EN 60204-1 and VDE 0113-1.

Features

- Dual-channel operation, with or without detection of shorts across the input contacts
- Monitored manual or automatic reset can be selected
- Designed for operation using semiconductor outputs
- Integrated safety cutout

Approvals

	PNOZ 8
	●
	●
	●

Technical Details	PNOZ 8
Electrical Data	
Supply Voltage	AC: 110, 230 V DC: 24 V
Tolerance	85 ... 110 %
Power Consumption	Approx. 4,5 W/6 VA
Frequency Range AC	50 ... 60 Hz
Residual Ripple DC	160 %
Voltage and Current at the Input and Reset Circuits and Feedback Control Loop	24 VDC, 50 mA
Output Contacts	3 safety contacts (N/O) 1 auxiliary contact (N/C)
Utilisation category in accordance with EN 60947-4-1	AC1: 240 V/8 A/2000 VA 400 V/5 A/2000 VA DC1: 24 V/8 A/200 W AC15: 230 V/5 A; DC13: 24 V/7 A
EN 60947-5-1 (DC13: 6 cycles/min.)	
Conventional thermal current	8 A
Contact Material	AgSnO ₂ + 0,2 µm Au
Contact Fuse Protection in accordance with EN 60947-5-1	10 A quick or 6 A slow
Semiconductor Outputs	24 VDC/50 mA, PNP short circuit protected
External Supply Voltage	24 VDC ±20 %
Times	
Delay-on Energisation	Approx. 150 ms
Delay-on De-energisation	Approx. 50 ms
Recovery Time	Approx. 300 ms
Simultaneity channel 1/2	Max. 180 ms
Max. Supply Interruption before De-energisation	Approx. 20 ms
Fuse Trip Delay	AC: approx. 350 ms, DC: approx. 150 ms
Mechanical Data	
Cable cross section	
1 core, flexible	0,20 - 4,00 mm ² , 24 - 10 AWG
2 core, same cross section flexible: with crimp connectors, without insulating sleeve	0,20 - 2,50 mm ² , 24 - 14 AWG
without crimp connectors or with TWIN crimp connectors	0,20 - 2,50 mm ² , 24 - 14 AWG
Dimensions (H x W x D)	87 x 90 x 121 mm
Weight	AC: 600 g, DC: 450 g

Description

- 90 mm P-97 housing, DIN-Rail mounting
- Positive-guided relay outputs:
 - 3 safety contacts (N/O)
 - 1 auxiliary contact (N/C)
- Connections for
 - E-STOP button
 - safety gate limit switch
 - reset button
- Safety cutout reset button
- LEDs for channel 1, channel 2, fault and power

- Increase in the number of safety contacts available by connecting expander modules.

Operating Modes

- Single-channel operation
- Dual-channel operation
- Automatic reset
- Manual reset
- Monitored manual reset

Up to PL e of EN ISO 13849-1 PNOZ 8

Internal Wiring Diagram

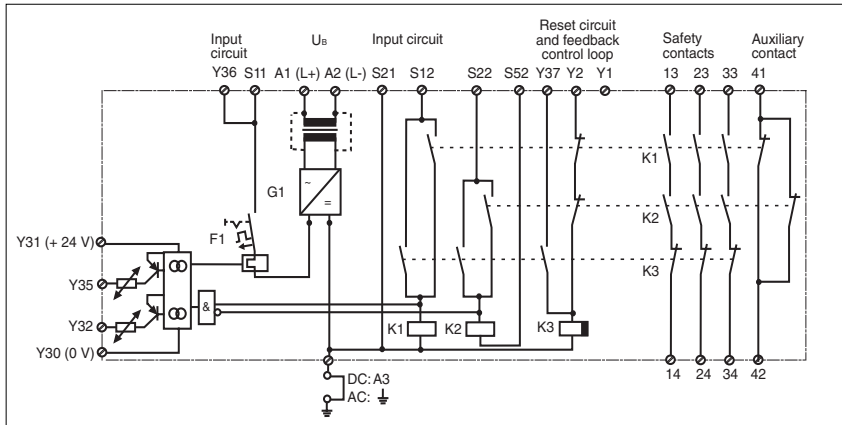

- Key

- S1/2: E-STOP or safety gate switch
- S3: Reset button
- Switch operated
- Gate open
- Gate closed

● Increase in safety contacts
The number of output contacts can be increased by using expander modules or relays/contactors with positive-guided contacts.

External Wiring

- Example 1
Single-channel E-STOP wiring with manual reset.

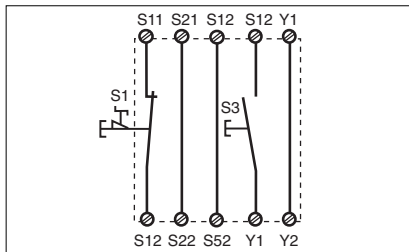

- Example 4
Dual-channel E-STOP wiring with monitored manual reset.

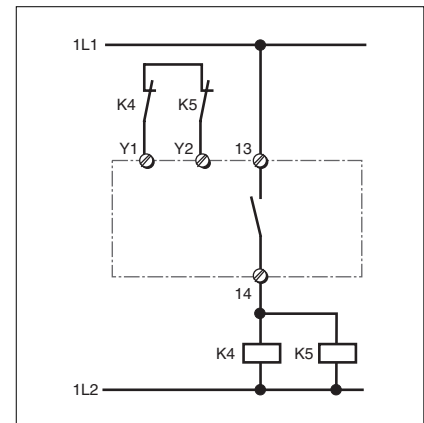
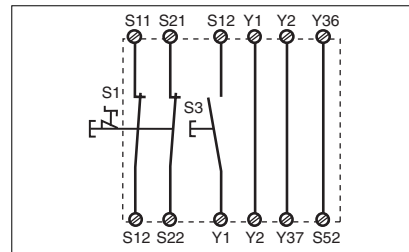

- Example 2
Dual-channel E-STOP wiring with manual reset.

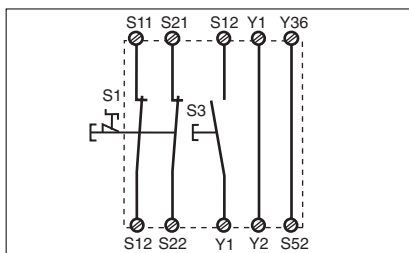

- Example 5
Dual-channel safety gate control with manual reset and infinite simultaneity.

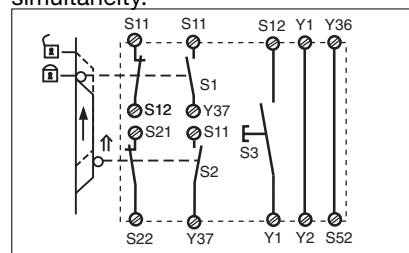

- Example 3
Dual-channel E-STOP wiring without short circuit detection across the input contacts.

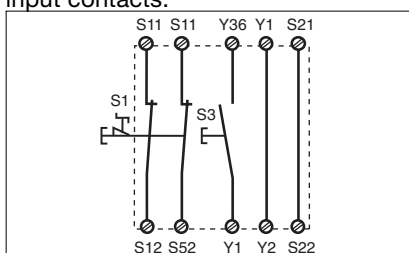

- Example 6
Dual-channel safety gate control with automatic reset.

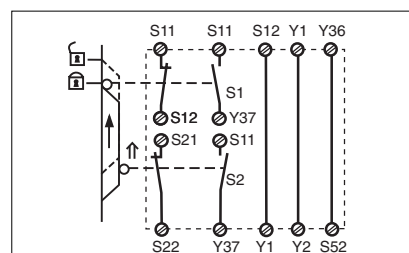

Up to PL e of EN ISO 13849-1 PNOZ 8

General Technical Data

Unless stated otherwise in the technical details for the specific unit

Safety-related characteristics

PL in accordance with EN ISO 13849-1	PL e (Cat. 4)
Category in accordance with EN 954-1	Cat. 4
SIL CL in accordance with EN IEC 62061	SIL CL 3
PFH in accordance with EN IEC 62061	2,31E-09
SIL in accordance with IEC 61511	SIL 3
PFD in accordance with IEC 61511	2,03E-06
t _M in years	20

Environmental Data

EMC	EN 60947-5-1, EN 61000-6-2
Vibration in accordance with EN 60068-2-6	Frequency: 10 ... 55 Hz, Amplitude: 0.35 mm
Climatic Suitability	EN 60068-2-78
Airgap Creepage in accordance with EN 60947-1	
Pollution degree	2
Overvoltage category	III
Rated insulation voltage	250 V
Rated impulse withstand voltage	4 kV
Ambient Temperature	-10 ... +55 °C
Storage Temperature	-40 ... +85 °C

Mechanical Data

Torque Setting on Connection Terminals	0.6 Nm (screws)
Mounting Position	Any
Housing Material	Housing: PPO UL 94 V0 Front panel: ABS UL 94 V0
Protection	Mounting: IP54 Housing: IP40 Terminal Range: IP20

The version of the standards current at 2009-07 shall apply.

Order References

Type	U _B	Order No.
PNOZ 8	24 V DC	774 760
PNOZ 8	110 V AC	774 764
PNOZ 8	230 V AC	774 768