

Up to Category 4, EN 954-1 PNOZ XV3P



Safety relay for monitoring E-STOP pushbuttons, safety gates and light barriers.

Approvals

PNOZ XV3P	
	◆
	◆
	◆

Unit features

- ▶ Positive-guided relay outputs:
 - 3 safety contacts (N/O), instantaneous
 - 2 safety contacts (N/O), delay-on de-energisation
- ▶ Connection options for:
 - E-STOP pushbutton
 - Safety gate limit switch
 - Reset button
 - Light barriers
- ▶ Delay-on de-energisation, fixed or selectable
- ▶ Delay time can be cancelled via reset button
- ▶ LED indicator for:
 - Switch status channel 1/2
 - Supply voltage
 - Reset circuit
- ▶ Plug-in connection terminals (either cage clamp terminal or screw terminal)
- ▶ See order reference for unit types

- ▶ Safety gates
- ▶ Light barriers

The max. category the safety contacts can achieve in accordance with EN 954-1 is stated in the technical details.

Safety features

The relay conforms to the following safety criteria:

- ▶ The circuit is redundant with built-in self-monitoring.
- ▶ The safety function remains effective in the case of a component failure.
- ▶ The correct opening and closing of the safety function relays is tested automatically in each on-off cycle.
- ▶ The unit has an electronic fuse.

Unit description

The safety relay meets the requirements of EN 60204-1 and IEC 60204-1 and may be used in applications with

- ▶ E-STOP pushbuttons

Block diagram

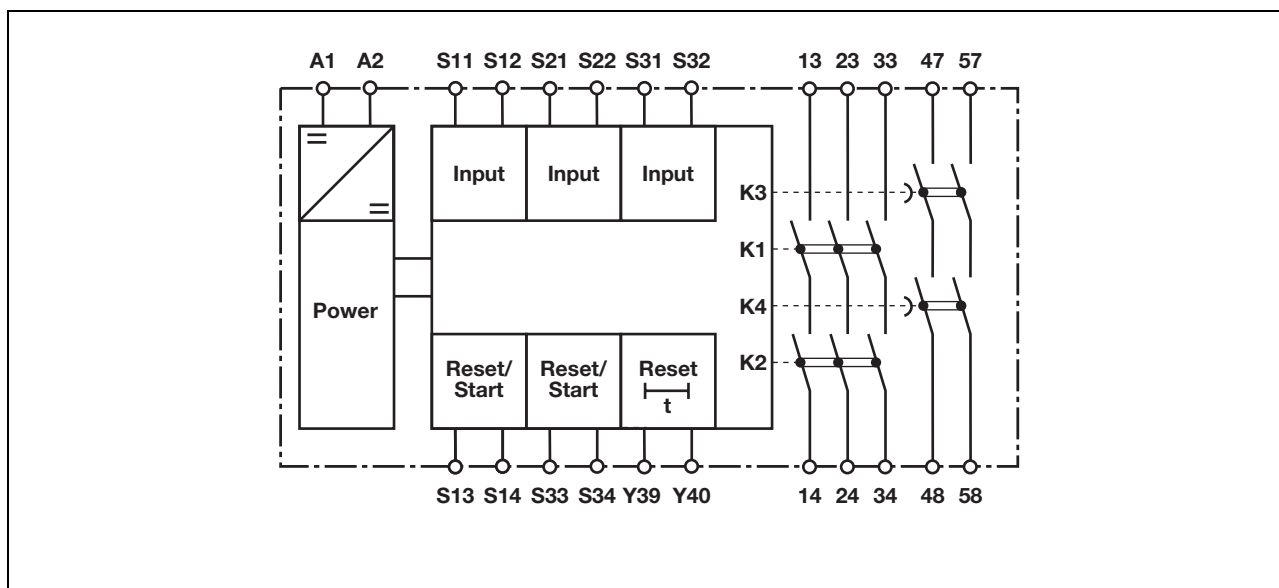

Up to Category 4, EN 954-1 PNOZ XV3P

Function description

- ▶ Single-channel operation: no redundancy in the input circuit, earth faults in the reset and input circuit are detected.
- ▶ Dual-channel operation without detection of shorts across contacts: redundant input circuit, detects
 - earth faults in the reset and input circuit,
 - short circuits in the input circuit
- ▶ Dual-channel operation with detection of shorts across contacts: redundant input circuit, detects
 - earth faults in the reset and input circuit,
 - short circuits in the input circuit and, with a monitored reset, in the reset circuit too,
 - shorts between contacts in the input circuit.
- ▶ Automatic start: Unit is active once the input circuit has been closed.
- ▶ Monitored reset: Unit is active once the input circuit is closed and once the reset circuit is closed after the waiting period has elapsed (see technical details).
- ▶ Increase in the number of available contacts by connecting contact expander modules or external contactors/relays.

Timing diagram

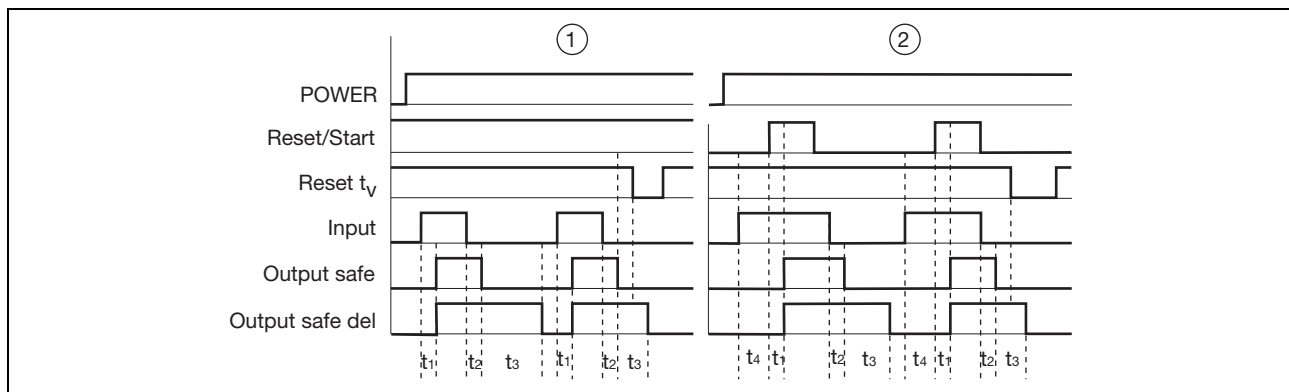

Key

- ▶ Power: Supply voltage
- ▶ Reset/start: Reset circuit S13-S14, S33-S34
- ▶ Reset t_v : Y39-Y40
- ▶ Input: Input circuits S11-S12, S21-S22, S31-S32
- ▶ Output safe: Safety contacts, instantaneous 13-14, 23-24, 33-34
- ▶ Output safe del: Safety contacts, delayed 47-48, 57-58
- ▶ ①: Automatic reset
- ▶ ②: Monitored reset
- ▶ t_1 : Switch-on delay
- ▶ t_2 : Delay-on de-energisation
- ▶ t_3 : Delay time
- ▶ t_4 : Waiting period

Wiring

Please note:

- ▶ Information given in the “Technical details” must be followed.
- ▶ Outputs 13-14, 23-24, 33-34 are instantaneous safety contacts, outputs 47-48, 57-58 are delay-on de-energisation safety contacts.
- ▶ To prevent contact welding, a fuse should be connected before the output contacts (see technical details).
- ▶ Calculation of the max. cable runs I_{max} in the input circuit:

$$I_{max} = \frac{R_{I_{max}}}{R_l / km}$$

$R_{I_{max}}$ = max. overall cable resistance (see technical details)

R_l / km = cable resistance/km

- ▶ Use copper wire that can withstand 60/75 °C.
- ▶ Sufficient fuse protection must be provided on all output contacts with capacitive and inductive loads.

Up to Category 4, EN 954-1 PNOZ XV3P

Preparing for operation

► Supply voltage

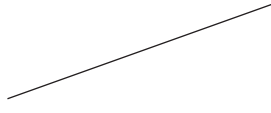
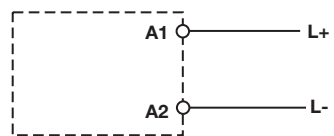

Supply voltage	AC	DC
		

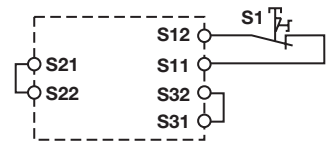
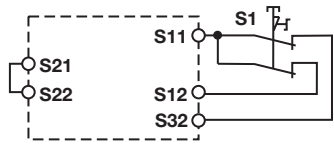
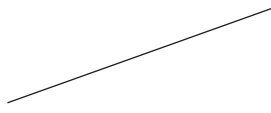
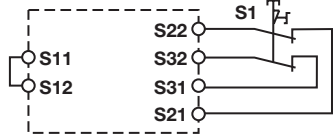
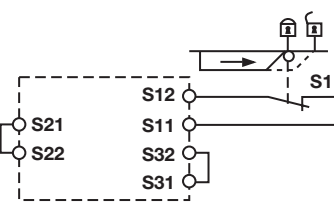
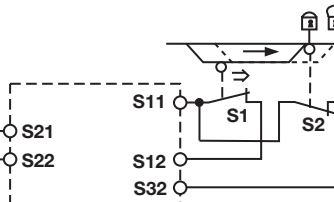
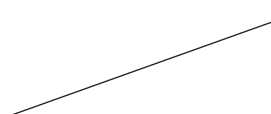
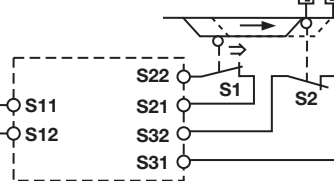
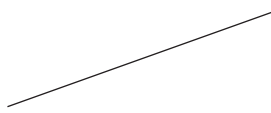
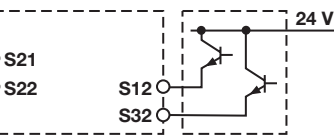
► Input circuit

Input circuit	Single-channel	Dual-channel
E-STOP without detection of shorts across contacts		
E-STOP with detection of shorts across contacts		
Safety gate without detection of shorts across contacts		
Safety gate with detection of shorts across contacts		
Light barrier with detection of shorts across contacts via ESPE		

Up to Category 4, EN 954-1 PNOZ XV3P

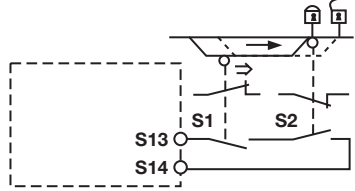
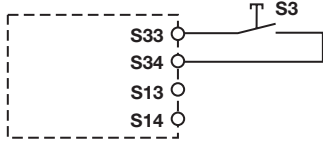
▶ Reset circuit

Reset circuit	E-STOP wiring, safety gate	Safety gate (dual-channel)
Automatic reset		
Monitored reset		

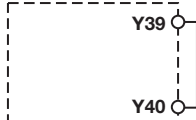
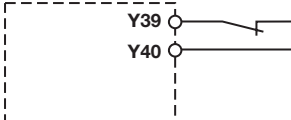

▶ Reset

Reset	Link	N/C contact for resetting the delay time
Link or N/C contact		

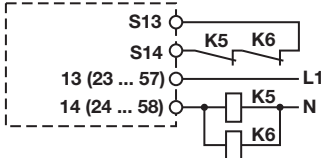
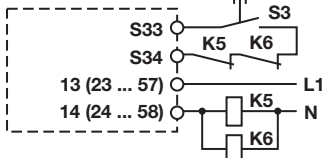
▶ Feedback loop

Feedback loop	Automatic reset	Monitored reset
Contacts from external contactors		

▶ Key

S1/S2	E-STOP pushbutton/ safety gate switch
S3	Reset button
	Switch operated
	Gate open
	Gate closed

Up to Category 4, EN 954-1 PNOZ XV3P

Terminal configuration

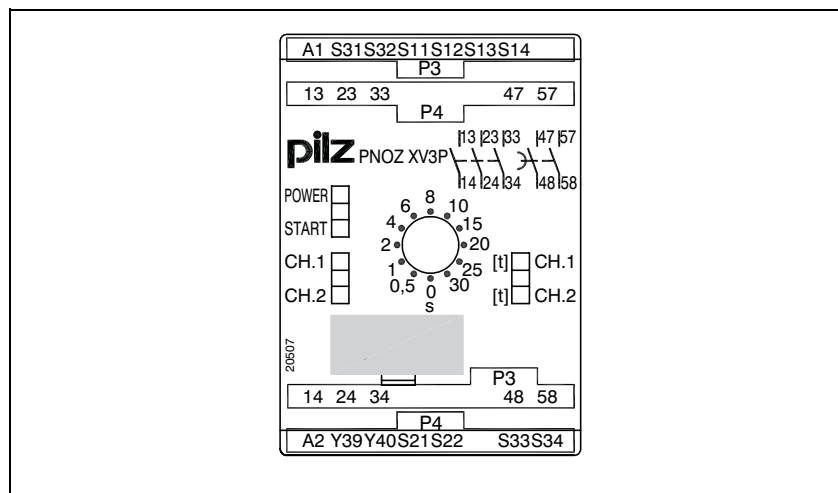

Installation

- ▶ The safety relay should be installed in a control cabinet with a protection type of at least IP54.
- ▶ Use the notch on the rear of the unit to attach it to a DIN rail.
- ▶ Ensure the unit is mounted securely on a vertical DIN rail (35 mm) by using a fixing element (e.g. retaining bracket or an end angle).

Dimensions

* with cage clamp terminals

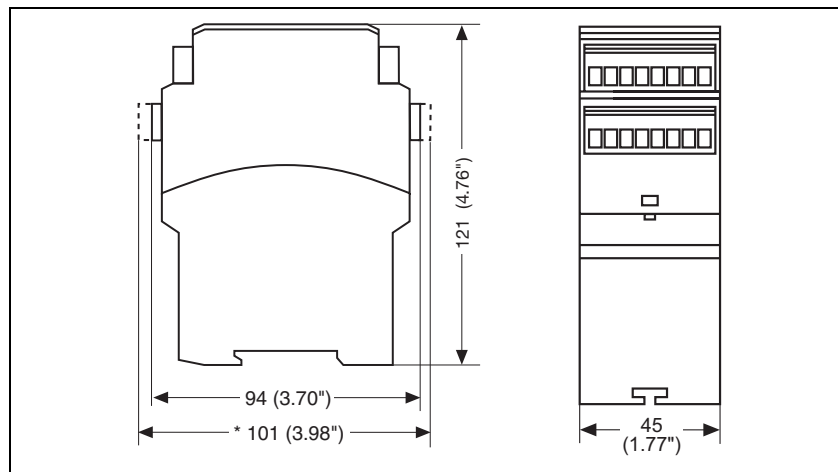

Up to Category 4, EN 954-1 PNOZ XV3P

Notice

This data sheet is only intended for use during configuration. For installation and operation, please refer to the operating instructions supplied with the unit.

Service life graph

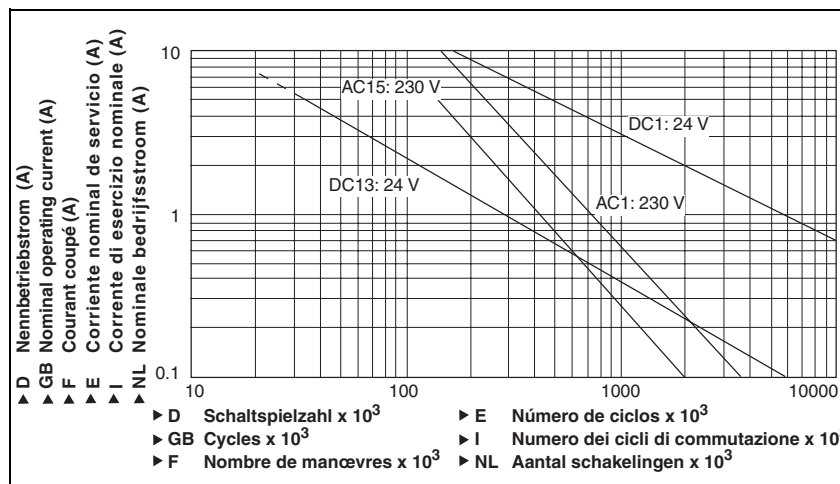

Technical details

Electrical data

Supply voltage U_B DC	24 V
Voltage tolerance	-15 % / + 10 %
Power consumption at U_B DC	4.5 W
Residual ripple DC	160 %
Voltage and current at input circuit: 24 VDC	
reset circuit: 24 VDC	45 mA
feedback loop: 24 VDC	50.0 mA
	1.0 mA
Output contacts in accordance with EN 954-1 , Category 4	Safety contacts (N/O): 3 ST
Output contacts in accordance with EN 954-1	Safety contacts (N/O), delayed: 2 ST
Category 1 Order no. 777 510, 777 518, 787 510, 787 518	If delay time >30 s
Category 3	If delay time <30 s
Utilisation category in accordance with EN 60947-4-1	
AC1: 240 V	$I_{min}: 0.01 A, I_{max}: 8 A$ $P_{max}: 2,000 VA$
DC1: 24 V	$I_{min}: 0.01 A, I_{max}: 8 A$ $P_{max}: 200 W$
Utilisation category in accordance with EN 60947-5-1	
AC15: 230 V	$I_{max}: 5 A$
DC13 (6 cycles/min): 24 V	$I_{max}: 7 A$
Contact material	AgSnO₂ + 0.2 μm Au
External contact fuse protection (EN 60947-5-1)	
Blow-out fuse, quick	10 A
Blow-out fuse, slow	6 A
Circuit breaker	6 A, 24 VAC/DC, characteristic B/C
Max. overall cable resistance R_{lmax} input circuits, reset circuits	
Single-channel at U_B DC	100 Ohm
Dual-channel without detect. of shorts across contacts at U_B DC	100 Ohm
Dual-channel with detect. of shorts across contacts at U_B DC	10 Ohm

Up to Category 4, EN 954-1 PNOZ XV3P

Times	
Switch-on delay	
with automatic reset typ.	350 ms
with automatic reset max.	650 ms
with automatic reset after power on typ.	385 ms
with automatic reset after power on max.	700 ms
with monitored reset typ.	35 ms
with monitored reset max.	70 ms
Delay-on de-energisation	
with E-STOP typ.	15 ms
with E-STOP max.	30 ms
with power failure typ.	85 ms
with power failure max.	200 ms
Recovery time at max. switching frequency 1/s after E-STOP after power failure	50 ms + t _v 250 ms
Delay time t _v selectable	0.10 s, 0.20 s, 0.30 s, 0.40 s, 0.50 s, 0.60 s, 0.70 s, 0.80 s, 1.00 s, 1.50 s, 2.00 s, 3.00 s Order no.: 777512, 787512 0.00 s, 0.50 s, 1.00 s, 2.00 s, 4.00 s, 6.00 s, 8.00 s, 10.00 s, 15.00 s, 20.00 s, 25.00 s, 30.00 s Order no.: 777510, 787510 0.00 s, 5.00 s, 10.00 s, 20.00 s, 40.00 s, 60.00 s, 80.00 s, 100.00 s, 150.00 s, 200.00 s, 250.00 s, 300.00 s Order no.: 777518, 787518
Fixed	0.5 s Order no.: 777514, 3.0 s Order no.: 777515, 10.0 s Order no.: 777517
Repetition accuracy	2 %
Time accuracy	-15% / +15% +50 ms
Waiting period with a monitored reset	300 ms
Min. start pulse duration with a monitored reset	30 ms
Simultaneity, channel 1 and 2	∞
Supply interruption before de-energisation	20 ms
Environmental data	
EMC	EN 60947-5-1, EN 61000-6-2
Vibration in accordance with EN 60068-2-6	
Frequency	10 – 55 Hz
Amplitude	0.35 mm
Climatic suitability	EN 60068-2-78
Airgap creepage	VDE 0110-1
Ambient temperature	-10 – 55 °C
Storage temperature	-40 – 85 °C
Protection type	
Mounting (e.g. cabinet)	IP54
Housing	IP40
Terminals	IP20
Mechanical data	
Housing material	
Housing	PPO UL94 VO
Front	ABS UL94 VO
Max. cross section of external conductors with screw terminals	
1 core flexible	0.25 - 2.50 mm ²
2 core, same cross section, flexible:	
with crimp connectors, without insulating sleeve	0.25 - 1.00 mm ²
without crimp connectors or with TWIN crimp connectors	0.20 - 1.50 mm ²
Torque setting with screw terminals	0.50 Nm
Max. cross section of external conductors with cage clamp terminals: Flexible without crimp connectors	0.2 - 1.5 mm ²
Cage clamp terminals	
Terminal points per connection	2
Stripping length	8 mm

Up to Category 4, EN 954-1 PNOZ XV3P

Mechanical data

Dimensions (H x W x D) with screw terminals	94 mm x 45 mm x 121 mm
with cage clamp terminals	101 mm x 45 mm x 121 mm
Weight	360 g Order no.: 777514, 777515, 777517, 787510, 787512, 787518
	370 g Order no.: 777510, 777512, 777518

The standards current on **08/02** apply.

Max. continuous current

Number of contacts	I_{max} (A) at U_B DC
1	8.0 A
2	6.8 A
3	5.5 A
4	4.8 A
5	4.3 A

Order reference

Type	Features	Terminals	Order no.
PNOZ XV3P	24 VDC	0.5 s fixed	Screw terminals 777 514
PNOZ XV3P	24 VDC	3 s fixed	Screw terminals 777 515
PNOZ XV3P	24 VDC	10 s fixed	Screw terminals 777 517
PNOZ XV3P C	24 VDC	3 s selectable	Cage clamp terminals 787 512
PNOZ XV3P	24 VDC	3 s selectable	Screw terminals 777 512
PNOZ XV3P C	24 VDC	30 s selectable	Cage clamp terminals 787 510
PNOZ XV3P	24 VDC	30 s selectable	Screw terminals 777 510
PNOZ XV3P C	24 VDC	300 s selectable	Cage clamp terminals 787 518
PNOZ XV3P	24 VDC	300 s selectable	Screw terminals 777 518